

M12 Steel male 0°/ M12 Steel female 0° A-cod. LED

PVC 4x0.34 gy UL/CSA 20m

F&B-Steel

Male straight – female straight

M12 – M12, 4-pole

1× LED (PNP)

Further cable lengths on request.

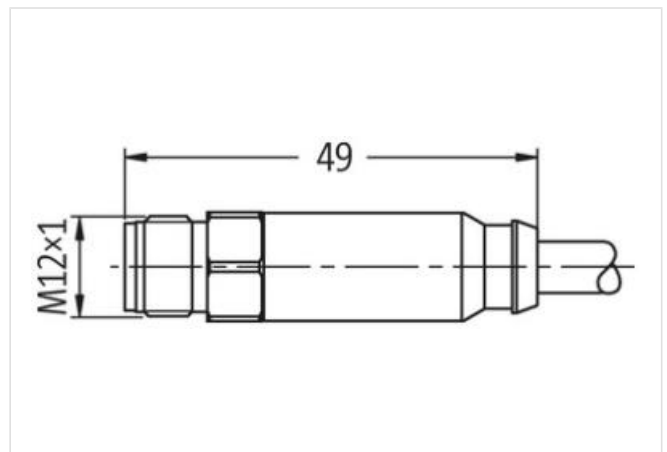
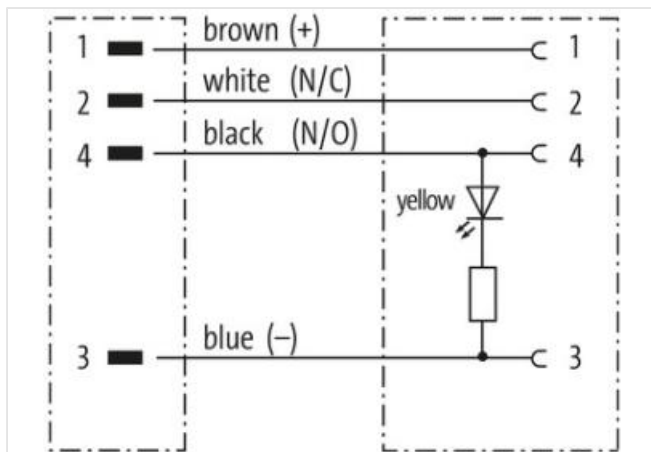
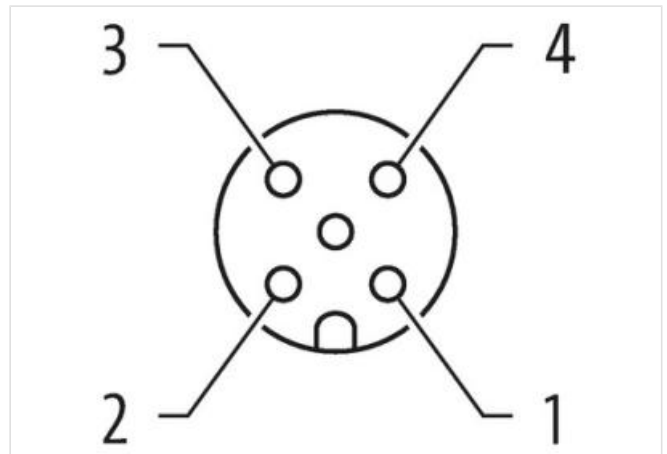
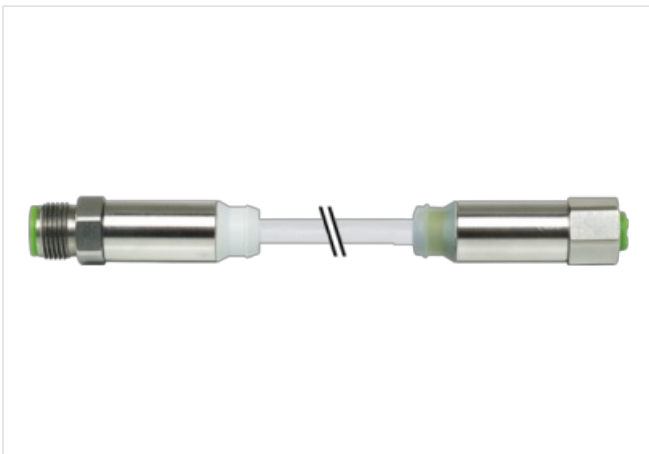
[Link to Product](#)**Illustration**

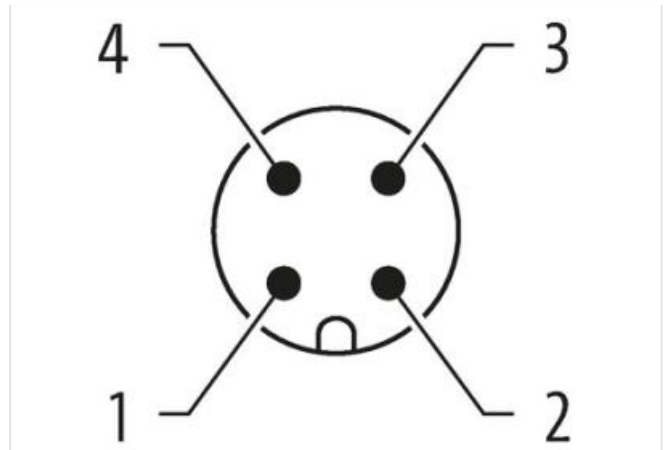
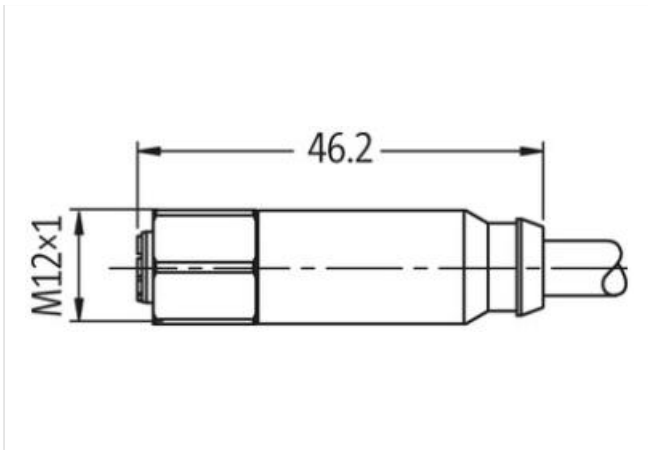

Product may differ from Image



Cable length 20 m

Side 1

Family construction form M12

Commercial data

ECLASS-6.0 27279218

ECLASS-7.0 27279218

ECLASS-8.0 27279218

ECLASS-9.0 27060311

ETIM-5.0 EC001855

customs tariff number 85444290

GTIN 4048879609319

Packaging unit 1

Electrical data | Supply

Operating voltage DC 24 V

Operating voltage DC min. 18 V

Operating voltage DC max. 30 V

Device protection | Electrical

Pollution Degree 3

Rated surge voltage 0,8 kV

Material group (IEC 60664-1) I

Environmental characteristics | Climatic

Operating temperature min. -40 °C

Operating temperature max. 85 °C

Additional condition temperature range depending on cable quality

Important installation notes

Note on strain relief Protect the connectors by suitable measures from mechanical loads, e.g. by the usage of cable ties.

Note on bending radius **Attention:** Observe the permissible bending radii when laying cables, as the IP protection class can be endangered by excessive bending forces.**Installation | Cable**

wire arrangement brown, black, blue, white

Cable identification 214

Cable Type	1
Jacket Color	gray
Type of Certificate	cURus
Amount stranding	1
Stranding	4 wires twisted
wire arrangement	brown, black, blue, white
Cable weight	40,7 g/m
Material jacket	PVC
Shore hardness jacket	85 ± 5 Shore A
Freedom from ingredients (jacket)	lead-free, cadmium-free, CFC-free, silicone-free
Outer-diameter (jacket)	5 mm
Tolerance outer diameter (sheath)	± 5 %
Material wire insulation	PVC
Amount wires	4
Outer diameter insulation	1,25 mm
Outer diameter tolerance core insulation	± 5 %
Shore hardness wire insulation	45 ± 5 Shore D
Material properties wire insulation	good machinability
Ingredient freeness wire insulation	lead-free, cadmium-free, CFC-free, silicone-free
Amount strands (wire)	19
Diameter of single wires	0,15 mm
Conductor crosssection (wire)	0,34 mm ²
Material conductor wire	Stranded copper wire, bare
Conductor type (wire)	Strand class 5
Nominal voltage AC max.	300 V
Current load capacity (standard)	to DIN VDE 0298-4
Current load capacity min. wire	4,8 A
Electrical resistance line constant wire	57 Ω/km @ 20 °C
AC withstand voltage (wire - wire)	2 kV @ 60 s
Power frequency withstand voltage (wire - jacket)	2 kV @ 60 s
Min. operating temperature (static)	-30 °C
Max. operating temperature (fixed)	80 °C
Operating temperature min. (dynamic)	-5 °C
Operating temperature max. (dynamic)	80 °C
Flame resistance	UL 1581 § 1100 FT2 IEC 60332-2-2 UL 1581 § 1090
chemical resistance	Good, application-related testing
Gasoline resistance	Good, application-related testing
Oil resistance	Good, application-related testing DIN EN 60811-404
Bending radius (fixed)	5 x Outer diameter
Bending radius (dynamic)	10 x Outer diameter